

IHI

CCH 2800

Fully Hydraulic Crawler Crane

Lifting Capacity 280 metric tons



IHI Construction Machinery Limited

Courtesy of Crane.Market

General Dimensions (with basic boom) (Unit : mm)

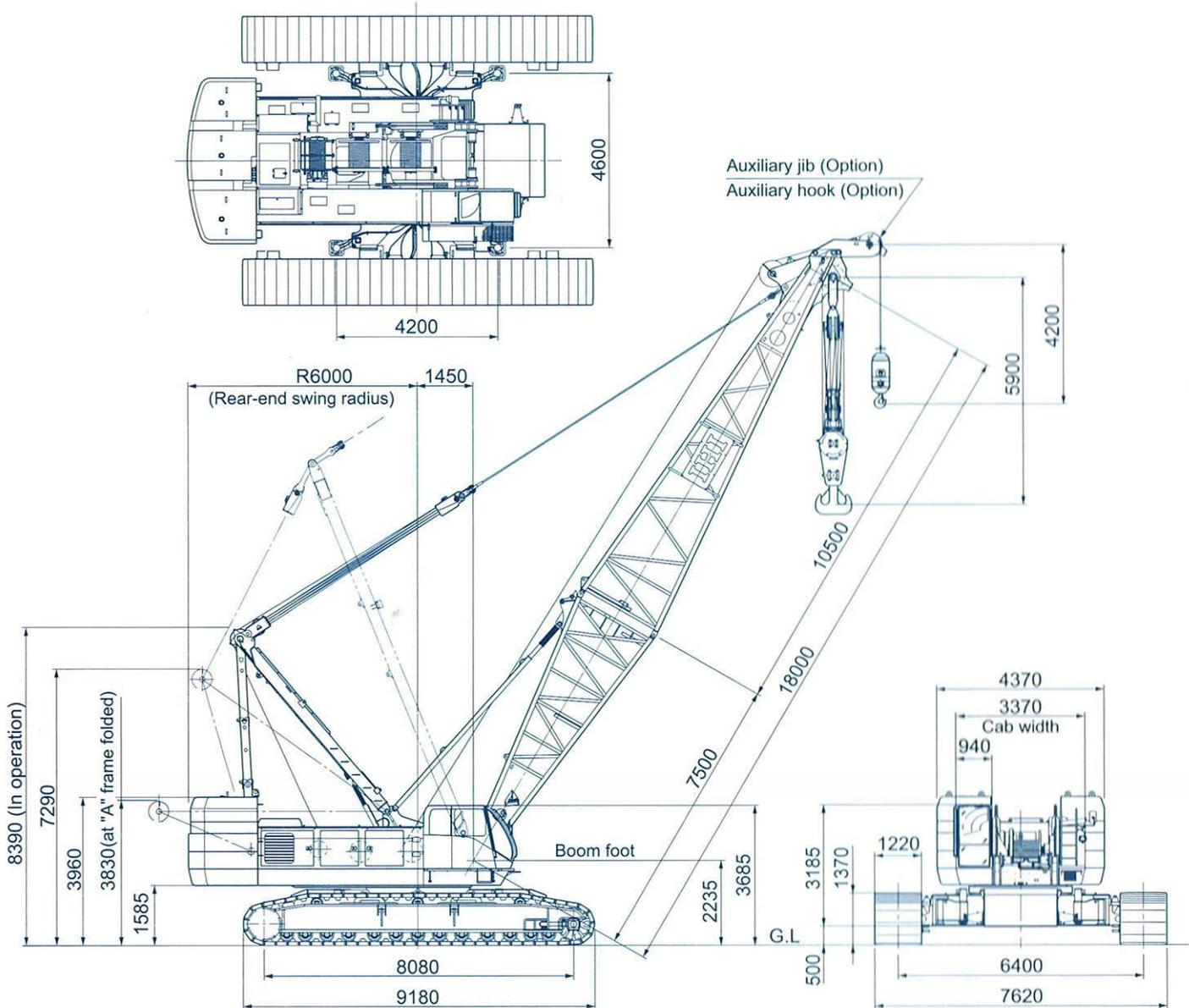

Specifications

Performance	
Swing speed	1.7rpm
Travel speed	0.9/0.5 km/hr
Gradeability	30% (16.7°)
Engine	
Make	HINO Motors
Model	K13C-UV (with turbo) diesel engine 6-cylinder, water cooled, overhead valve
Type	Direct injection diesel engine
Total piston displacement	12,882L
Rated output	374PS/2,000rpm (275kw/2000min ⁻¹)
Fuel tank capacity	450L
Battery	12V × 150AH × 2 pcs.
Load hoist System (Main & Aux.)	
Hydraulic motor	Axial piston type
Reduction gear	Two-stage planetary gear
Hoist drum	2-grooved cylindrical drums on 2 individual shaft. Main/Auxiliary drum in same width, with Lebus type groove.
Brake	Wet type multi disc
Drum locks	Ratchet lock
Boom hoist System	
Motor	Axial piston type
Reduction gear	Three-stage planetary gear
Hoist drum	2 grooved cylindrical drums on 1-single shaft, with Lebus type groove
Brake	Wet type multi disc
Drum lock	Ratchet lock

Crane specifications

Max.lifting capacity (metric ton) × working radius (m)	280 × 5.0	
Max.boom length (m)	90	
Max.boom length,main (main+jib boom) (m)	109(72+37)	
Rope speed	Main drum hoist/lowering (m/min)	* 120/60-55/28
	Aux.drums hoist/lowering (m/min)	* 120/60-55/28
	Boom drum hoist/lowering (m/min)	* 32~14 × 2
Parts lines	Hook block capacity (ton) × part line	280 × 20
	Hook block capacity (ton) × part line	25 × 2
	Boom drum hoist/lowering part line	18
Counterweight (ton)	87	
Total operating weight (with 18m basic boom) (ton)	Approx. 210.5	
Average ground bearing pressure (kPa) [kgf/cm ²]	(105) [1.07]	

* The rope speed changes depending on the load.

Standard equipment

- Engine tachometer (with hour meter)
- Hydraulic pressure gauge
- Fuel gauge
- Engine coolant temperature gauge
- Front work lamp (on both sides)
- Operator's room lamp
- Front windshield wiper (with window washer)
- Ceiling wiper (with window washer)
- Sun shade
- Sun-visor
- Storage pouch
- Tool storage
- Reclining operator's seat
- Floor mat
- Steps for operator's cab
- Radio (AM/FM, Cassette)
- Cigarette lighter
- Ashtray
- Rear view mirrors (on both sides)
- Warning horn
- Moment limiter
- Electric fuel pump
- Slewing flashing light
- Slewing warning Buzzer (with voice alarm)
- Travel warning Buzzer (with voice alarm)
- A-frame hoist cylinder
- Bronze tinted glass
- Wire mesh boom walkway (for inner boom)
- Foot rest
- Electrical engine throttle control grip
- Engine throttle pedal
- Ultra low speed control
- Automatic hydraulic brake (main, aux. and boom hoist motor)
- Rope guide roller on boom back (for outer boom)
- Plug socket (24V)
- Loud speaker
- Winch speed control system (main, aux. and boom hoist)
- Pump power-shift system
- Switch of emergency stop (front and rear)
- Boom foot pin cylinder
- Crawler connecting pin cylinder
- Standard tools for maintenance (details are as per Parts Catalogue)
- Remote controller for jack and crawler connect cylinder

Options

1. Base Machine
 - Reeving winch
 - Tagline
 - Slewing parking break
 - Constant speed slewing system
 - Slewing mode select switch (free/break)
 - Drum rotation indication
 - Monitor TV (for rear/drum view)
 - Monitor TV (for hook load)
 - Mirror for drum
 - Radio transmitter
 - Combustion type heater
 - Fire extinguisher
 - Room mirror
 - Electric fan
 - Spark arrestor
 - Operator gate lock lever
 - Tool box (installed in front of operator cabin)
 - Name plate (both side of base machine)
 - Air conditioner
2. Light and Instrument
 - Yellow rotary light
 - Airplane warning light
 - Boom point clearance lamp
 - Over load outside alarm light (red/yellow/green)
 - Work light for drum
 - Work light on boom
 - Work light for rear direction
 - Additional Front work light
 - Hand light
 - Electric clinometer
 - Level indicator
 - Anemometer
3. Step and guard
 - Catwalk for rear cab
 - Catwalk for rear cab (wide type with handrail)
 - Handrail for catwalk
 - Wire mesh for boom walkway (for insert boom and outer boom)
 - Operator cabin roof guard
 - Wire rope guard for insert boom
 - Hook guard for outer boom (wood or steel pipe)
 - Safety guard rope on main boom
4. Attachment
 - 3m, 6m, 9m insert boom (with pendant rope and rope guide roller)
 - 13m basic jib and accessories
 - 6m insert jib (with pendant rope)
 - 1m auxiliary jib and accessories
 - 150 ton hook block (six sheaves)
 - 100 ton hook block (four sheaves)
 - 60 ton hook block (three sheaves)
 - 25/30 ton hook block (one sheave)
 - 13.5 ton hook block (slim type)
 - Auxiliary hoisting wire rope
 - Mast (with middle suspension rope)
 - Name plate (both side of outer boom)
5. Others
 - Large size tool box (with caster)
 - Sling wire rope (for lifting counter weight or crawler)

Combination of main boom and jib boom

Jib length (m)	Boom length(m)																
	18-42	45	48	51	54	57	60	63	66	69	72	75	78	81	84	87	90
Aux.	●	●	●	●	●	●	●	●	●	●	●	●	●	●	●	●	●
13		●	●	●	●	●	●	●	●	●	●	●	●	●	●	●	●
19		●	●	●	●	●	●	●	●	●	●	●	●	●	●	●	●
25		●	●	●	●	●	●	●	●	●	●	●	●	●	●	●	●
31		●	●	●	●	●	●	●	●	●	●	●	●	●	●	●	●
37		●	●	●	●	●	●	●	●	●	●	●	●	●	●	●	●

●:Applicable combination

Wire rope

Purpose	Rope dia. (mm)	Breaking Strength (kN)	Rope Type
Main hoisting	φ28	688	P-S(19)+39×P-7
Main hoisting	φ28	674	IWRC 6×P-WS(36)
Boom hoisting	φ22	406	IWRC 6×P-WS(31)
Boom suspension	φ34	1024	IWRC 6×P-WS(36)
Jib load hoisting	φ28	688	P-S(19)+39×P-7
Jib boom suspension	φ28	585	IWRC 6×Fi(29)
Jib strut suspension	φ31.5	734	IWRC 6×Fi(29)

Note:Designed and rated to comply with ANSI Code B30.5-1.7.1

Boom composition

The following tables show standard combinations for each boom length.

Combination \ Boom length(m)	18	21	24	27	30	33	36	39	42	45	48	51	54
	7.5m inner	1	1	1	1	1	1	1	1	1	1	1	1
3.0m insert	—	1	2	1	2	1	1	2	1	1	2	1	1
6.0m insert	—	—	—	1	1	2	1	1	2	1	1	2	1
9.0m insert	—	—	—	—	—	—	1	1	1	2	2	2	3
10.5m outer	1	1	1	1	1	1	1	1	1	1	1	1	1

Combination \ Boom length(m)	57	60	63	66	69	72	75	78	81	84	87	90
	7.5m inner	1	1	1	1	1	1	1	1	1	1	1
3.0m insert	2	1	1	2	1	1	2	1	1	2	1	1
6.0m insert	1	2	1	1	2	1	1	2	1	1	2	1
9.0m insert	3	3	4	4	4	5	5	5	6	6	6	7
10.5m outer	1	1	1	1	1	1	1	1	1	1	1	1

Note:Installation of mast is required for boom length exceeding 69m.

Jib boom composition

Combination \ Jib boom length(m)	13	19	25	31	37
	6.5m inner	1	1	1	1
6.0m insert	—	1	2	3	4
6.5m outer	1	1	1	1	1

Working range (No loaded condition)

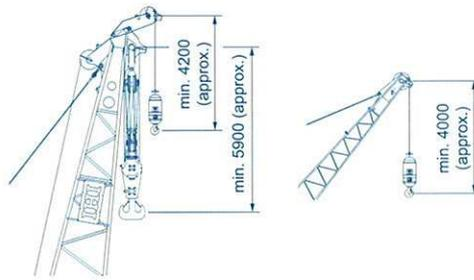

Main boom + auxiliary jib

Auxiliary jib

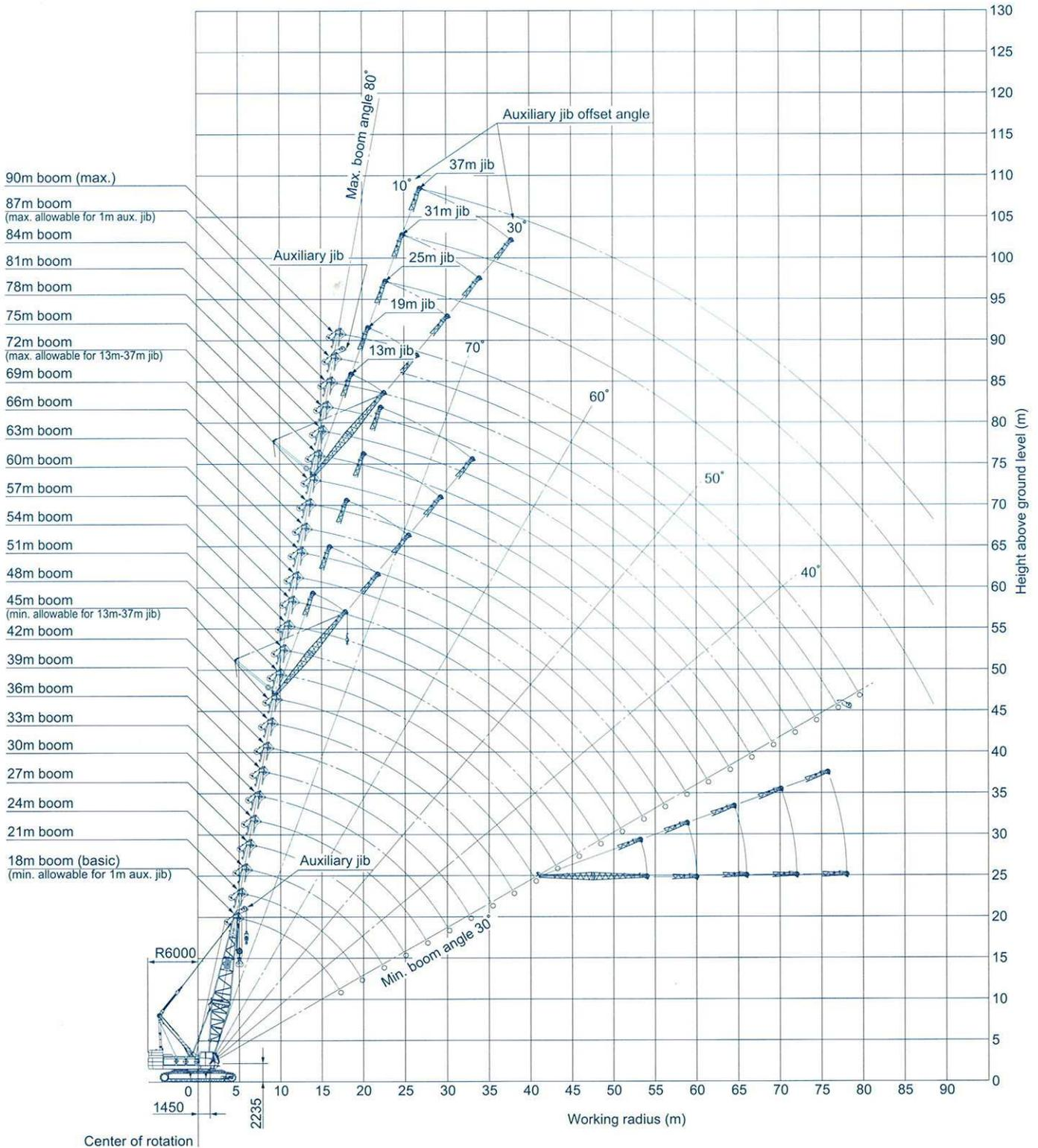

Rated lifting loads (87ton counterweight, 16ton weight for body)

(Unit : Metric ton)

Boom length(m) Working radius(m)	18	21	24	27	30	33	36	39	42	45	48	51	54
No. of Part line	20	14	14	12	11	12	11	10	9	9	7	7	6
5.0	280.0	5.6m ×175.0											
6.0	195.8	175.0	6.1m ×175.0	6.6m ×150.0									
7.0	167.0	166.3	161.2	150.0	7.2m ×137.5	7.7m ×142.8							
8.0	146.9	146.2	145.9	145.6	137.5	142.8	8.2m ×137.5	8.7m ×125.0					
9.0	130.3	130.4	130.1	129.7	127.7	130.6	128.5	125.0	9.2m ×112.5	9.8m ×110.2			
10.0	117.0	116.9	117.2	116.9	117.2	117.3	116.8	114.8	109.1	107.5	10.3m ×87.5	10.8m ×87.5	11.3m ×75.0
12.0	89.8	90.4	90.7	91.0	91.5	91.3	91.4	91.2	90.9	87.8	86.0	85.7	75.0
14.0	72.2	72.0	72.6	72.7	73.5	73.3	73.3	73.1	72.8	72.7	71.3	69.9	69.8
16.0	60.3	60.0	59.8	60.1	60.9	60.9	61.0	60.8	60.5	60.3	59.1	58.8	58.6
18.0	17.2m ×54.0	51.2	51.0	50.7	51.7	51.7	51.9	51.7	51.4	51.3	50.2	49.9	49.7
20.0		19.8m ×45.2	44.4	44.0	44.5	44.6	44.9	44.9	44.5	44.4	43.4	43.1	42.9
22.0			39.1	38.8	39.2	38.9	39.3	39.3	39.1	39.0	38.1	37.8	37.6
24.0			22.4m ×38.2	34.6	34.9	34.6	34.6	34.7	34.5	34.4	33.8	33.4	33.3
26.0				25.0m ×32.7	31.5	31.1	31.1	30.8	30.8	30.6	30.2	29.9	29.7
28.0					27.6m ×29.2	28.2	28.1	27.9	27.5	27.4	27.3	26.9	26.8
30.0						25.7	25.6	25.4	25.0	24.8	24.7	24.4	24.3
32.0						30.2m ×25.4	23.5	23.2	22.8	22.7	22.6	22.3	22.1
34.0							32.8m ×22.6	21.4	21.0	20.8	20.7	20.4	20.3
36.0								35.4m ×20.2	19.4	19.2	19.1	18.8	18.7
38.0									18.0	17.8	17.7	17.4	17.2
40.0										16.5	16.4	16.1	15.9
42.0										40.6m ×16.1	15.3	15.0	14.8
44.0											43.2m ×14.7	13.9	13.8
46.0												45.8m ×13.2	12.8
48.0													12.0
50.0													48.4m ×11.8

Boom length(m) Working radius(m)	57	60	63	66	69	72	75	78	81	84	87	90
No. of Part line	6	6	6	5	5	4	4	4	3	3	3	2
10.0	11.9m ×75.0											
12.0	75.0	12.4m ×75.0	12.9m ×75.0	13.4m ×62.5	13.9m ×62.5							
14.0	69.6	69.6	69.4	62.5	62.5	14.5m ×50.0	15.0m ×50.0	15.5m ×50.0				
16.0	57.9	57.8	57.7	57.5	57.3	50.0	50.0	48.7	37.5	16.5m ×37.5	17.1m ×37.5	17.6m ×25.0
18.0	49.7	49.4	48.9	48.6	48.5	48.4	47.7	45.5	37.5	37.5	37.4	25.0
20.0	42.9	42.6	42.5	42.4	41.8	41.7	41.6	41.4	37.5	37.5	34.8	25.0
22.0	37.5	37.2	37.2	37.0	36.7	36.5	36.3	36.1	35.9	34.8	32.3	25.0
24.0	33.2	33.0	32.8	32.6	32.3	32.2	32.1	31.9	31.6	31.5	29.9	25.0
26.0	29.6	29.4	29.3	29.1	28.8	28.7	28.6	28.3	28.1	28.0	27.7	24.4
28.0	26.7	26.5	26.3	26.1	25.9	26.2	25.6	25.4	25.1	25.0	24.8	22.6
30.0	24.1	24.0	23.8	23.5	23.4	24.0	23.6	23.3	22.6	22.5	22.2	21.1
32.0	21.9	21.8	21.6	21.3	21.2	21.8	21.6	21.4	21.1	20.3	20.0	19.7
34.0	20.0	20.0	19.7	19.5	19.3	19.9	19.6	19.4	19.3	18.9	18.2	17.9
36.0	18.4	18.4	18.1	17.9	17.7	18.2	17.9	17.7	17.5	17.2	16.5	16.3
38.0	16.9	16.9	16.6	16.4	16.2	16.7	16.4	16.2	16.0	15.7	15.0	14.8
40.0	15.6	15.6	15.3	15.1	14.9	15.4	15.0	14.8	14.7	14.4	14.1	13.5
42.0	14.5	14.5	14.2	14.0	13.8	14.1	13.8	13.6	13.4	13.1	12.9	12.3
44.0	13.4	13.4	13.1	12.9	12.7	13.0	12.7	12.5	12.3	12.0	11.6	11.3
46.0	12.5	12.5	12.2	12.0	11.8	12.0	11.7	11.5	11.3	11.0	10.6	10.3
48.0	11.7	11.6	11.3	11.1	10.9	11.1	10.8	10.6	10.4	10.1	9.7	9.3
50.0	10.9	10.9	10.5	10.3	10.1	10.3	10.0	9.8	9.6	9.2	8.9	8.4
52.0	51.0m ×10.5	10.1	9.8	9.6	9.4	9.6	9.2	9.0	8.7	8.5	8.0	7.6
54.0		53.6m ×9.4	9.2	9.0	8.7	8.9	8.4	8.2	7.9	7.8	7.2	6.9
56.0			8.6	8.3	8.0	8.1	7.7	7.4	7.2	7.3	6.5	6.2
58.0			56.2m ×8.5	7.8	7.5	7.4	7.0	6.7	6.5	6.6	5.8	5.6
60.0				58.9m ×7.5	6.9	6.8	6.3	6.1	5.8	5.9	5.3	4.9
62.0					61.4m ×6.4	6.2	5.7	5.5	5.2	5.3	4.7	4.2
64.0						5.6	5.3	5.1	4.6	4.7	4.1	3.5
66.0							4.8	4.6	4.1	4.2	3.6	2.9
68.0								66.6m ×4.6	4.1	3.8	3.1	2.4
70.0									69.2m ×3.8	3.3	2.6	2.2
72.0										71.8m ×2.9	2.7	2.2
74.0											2.3	
76.0											74.4m ×2.2	

Jib rated lifting loads (87ton counterweight, 16ton weight for body)

(Unit : Metric ton)

Boom length (m)	45										48									
	13		19		25		31		37		13		19		25		31		37	
	10°	30°	10°	30°	10°	30°	10°	30°	10°	30°	10°	30°	10°	30°	10°	30°	10°	30°	10°	30°
No. of part line	2	2	2	1	1	1	1	1	1	1	2	2	2	1	1	1	1	1	1	1
14	25.0																			
16	25.0		16.5m x 22.0								15.0m x 25.0		17.0m x 21.9							
18	25.0	19.6	20.4		18.5m x 13.5						25.0	18.5m x 19.6	20.7		19.0m x 13.1					
20	25.0	18.9	19.7		13.0		20.5m x 7.2				25.0	19.0	19.9		13.0		21.0m x 7.2			
22	24.3	18.4	19.0	22.5m x 13.5	12.7		7.1		22.5m x 5.0		24.7	18.6	19.2	23.0m x 13.5	12.8		7.1		23.0m x 5.0	
24	23.3	17.6	18.3	13.5	12.5		7.0		5.0		23.8	17.9	18.6	13.5	12.6		7.0		5.0	
26	22.3	16.9	17.7	13.4	12.3	8.7	6.8		4.9		22.9	17.2	18.0	13.5	12.4	26.5m x 8.8	6.9		4.9	
28	21.4	16.3	17.2	13.1	12.1	8.5	6.7		4.8		22.0	16.6	17.5	13.2	12.2	8.6	6.8		4.8	
30	20.4	15.8	16.7	12.7	11.9	8.4	6.6	5.5	4.7		21.1	16.1	17.0	12.9	12.0	8.4	6.6	30.5m x 8.3	4.8	
32	19.5	15.3	16.2	12.2	11.6	8.2	6.5	5.4	4.6		20.1	15.6	16.5	12.4	11.8	8.3	6.5	5.4	4.6	
34	18.8	14.8	15.8	11.8	11.4	8.0	6.4	5.4	4.4	3.2	19.3	15.1	16.0	12.0	11.6	8.1	6.4	5.4	4.5	34.5m x 3.2
36	18.0	14.4	15.0	11.4	11.2	7.9	6.2	5.3	4.2	3.1	18.7	14.7	15.5	11.6	11.4	8.0	6.3	5.3	4.3	3.2
38	17.3	14.1	14.2	11.1	11.0	7.7	6.1	5.2	4.0	3.1	17.5	14.3	14.8	11.3	11.1	7.8	6.2	5.3	4.1	3.1
40	16.4	13.7	13.6	10.8	10.8	7.5	6.0	5.2	3.9	3.0	16.1	14.0	14.1	11.0	10.9	7.7	6.1	5.2	4.0	3.1
42	15.2	13.5	13.0	10.5	10.6	7.4	5.9	5.1	3.7	3.0	14.9	13.7	13.5	10.7	10.7	7.5	5.9	5.1	3.8	3.0
44	14.1	13.2	12.5	10.2	10.3	7.2	5.7	5.0	3.6	2.8	13.8	13.4	13.0	10.4	10.5	7.3	5.8	5.1	3.7	2.9
46	13.1	13.0	12.0	10.0	10.1	7.1	5.6	4.9	3.5	2.8	12.8	13.1	12.5	10.2	10.3	7.2	5.7	5.0	3.6	2.8
48	12.2	12.4	11.6	9.8	9.9	6.9	5.5	4.8	3.3	2.7	11.9	12.2	12.0	10.0	10.1	7.0	5.6	4.9	3.4	2.7
50	11.3	11.5	11.2	9.6	9.7	6.7	5.4	4.8	3.2	2.6	11.1	11.3	11.5	9.8	9.9	6.9	5.5	4.8	3.3	2.6
52	10.6	10.7	10.8	9.4	9.5	6.6	5.3	4.7	3.1	2.5	10.3	10.5	10.8	9.6	9.7	6.7	5.4	4.7	3.2	2.6
54	53.0m x 10.0	53.5m x 10.0	10.4	9.3	9.2	6.4	5.1	4.6	3.0	2.5	9.6	9.7	10.1	9.4	9.5	6.6	5.3	4.7	3.1	2.5
56			9.7	9.2	9.0	6.3	5.0	4.6	2.9	2.4	55.5m x 3.0	9.0	9.4	9.3	9.3	6.4	5.1	4.6	3.0	2.5
58			9.1	9.1	8.8	6.3	4.9	4.5	2.8	2.4		56.5m x 8.8	8.8	9.1	9.0	6.3	5.0	4.6	2.9	2.4
60			58.5m x 8.8	8.7	8.6	6.3	4.8	4.4	2.7	2.3			8.2	8.5	8.6	6.3	4.9	4.5	2.8	2.4
62					8.3	6.3	4.7	4.4	2.7	2.3			61.0m x 7.9	7.9	8.1	6.3	4.8	4.4	2.7	2.3
64					7.8	6.3	4.5	4.3	2.6	2.2			62.5m x 7.0	7.6	6.3	4.7	4.4	2.7	2.3	
66					64.5m x 7.7	6.3	4.4	4.3	2.5	2.2				7.1	6.3	4.6	4.3	2.6	2.2	
68							4.3	4.3	2.4	2.2				67.0m x 6.9	6.3	4.4	4.3	2.5	2.2	
70							4.2	4.2	2.4	2.1										
72								4.2	2.3	2.1										
74									2.2	2.1										
76									75.0m x 2.2	2.1										
78										2.1										
80																				
82																				2.1
84																				80.5m x 2.1

Boom length (m)	51										54										
	13		19		25		31		37		13		19		25		31		37		
	10°	30°	10°	30°	10°	30°	10°	30°	10°	30°	10°	30°	10°	30°	10°	30°	10°	30°	10°	30°	
No. of part line	2	2	2	1	1	1	1	1	1	1	2	2	2	1	1	1	1	1	1	1	
14	15.5m x 25.0																				
16	25.0		17.5m x 21.8																		
18	25.0	19.0m x 19.6	20.9		19.5m x 13.2						25.0	19.0m x 19.6	21.8								
20	25.0	19.1	20.1		13.1		21.5m x 7.2				25.0	19.2	20.4			13.1					
22	25.0	18.7	19.5	23.5m x 13.5	12.9		7.1		23.5m x 5.0		25.0	18.8	19.7			12.9		7.2			
24	24.2	18.2	18.8	13.5	12.7		7.0		5.0		24.6	18.4	19.1	13.5	12.7		7.1		24.5m x 5.0		
26	23.3	17.5	18.3	13.5	12.5	27.0m x 8.8	6.9		4.9		23.8	17.8	18.5	13.5	12.5	27.5m x 8.8	7.0		4.9		
28	22.5	16.9	17.7	13.3	12.3	8.6	6.8		4.9		23.0	17.2	18.0	13.4	12.4	8.7	6.8		4.9		
30	21.6	16.4	17.2	13.1	12.1	8.5	6.7	31.0m x 5.5	4.8		22.2	16.6	17.5	13.1	12.2	8.5	6.7	31.5m x 5.5	4.8		
32	20.8	15.9	16.8	12.6	11.9	8.3	6.6	5.5	4.7		21.3	16.1	17.0	12.8	12.0	8.4	6.6	5.5	4.7		
34	19.9	15.4	16.3	12.2	11.7	8.2	6.5	5.4	4.6	35.0m x 3.2	20.3	15.7	16.6	12.4	11.8	8.2	6.5	5.4	4.6	35.5m x 3.2	
36	18.8	15.0	15.9	11.9	11.5	8.0	6.4	5.4	4.4	3.2	18.6	15.3	16.2	12.0	11.6	8.1	6.4	5.4	4.5	3.2	
38	17.3	14.6	15.3	11.5	11.3	7.9	6.3	5.3	4.2	3.1	17.1	14.9	15.8	11.7	11.4	8.0	6.3	5.3	4.3	3.1	
40	15.9	14.3	14.6	11.2	11.1	7.7	6.1	5.2	4.0	3.1	15.7	14.5	15.1	11.4	11.2	7.8	6.2	5.3	4.1	3.1	
42	14.7	13.9	14.0	10.9	10.9	7.6	6.0	5.2	3.9	3.0	14.5	14.2	14.4	11.1	11.0	7.7	6.1	5.2	4.0	3.1	
44	13.6	13.7	13.4	10.6	10.7	7.4	5.9	5.1	3.8	3.0	13.4	13.8	13.8	10.8	10.8	7.5	6.0	5.2	3.8	3.0	
46	12.6	13.0	12.9	10.4	10.5	7.3	5.8	5.0	3.6	2.8	12.3	12.8	12.9	10.6	10.6	7.4	5.9	5.1	3.7	2.9	
48	11.7	12.0	12.2	10.2	10.3	7.2	5.7	4.9	3.5	2.8	11.4	11.8	12.0	10.3	10.4	7.3	5.8	5.0	3.6	2.8	
50	10.8	11.1	11.3	9.9	10.1	7.0	5.6	4.9	3.4	2.7	10.6	10.9	11.1	10.1	10.2	7.1	5.7	4.9	3.5	2.7	
52	10.0	10.3	10.6	9.7	9.9	6.9	5.5	4.8	3.3	2.6	9.8	10.1	10.3	9.9	10.0	7.0	5.6	4.8	3.4	2.7	
54	9.3	9.6	9.8	9.6	9.7	6.7	5.4	4.7	3.2	2.6	9.1	9.4	9.6	9.7	9.9	6.8	5.5	4.8	3.3	2.6	
56	8.7	8.9	9.2	9.4	9.5	6.6	5.2	4.7	3.1	2.5	8.5	8.7	9.0	9.5	9.3	6.7	5.3	4.7	3.2	2.5	
58	8.1	8.2	8.6	8.9	8.9	6.4	5.1	4.6	3.0	2.4	7.9	8.0	8.4	8.8	8.7	6.6	5.2	4.7	3.1	2.5	
60			59.0m x 7.8	8.0	8.3	8.3	6.3	5.0	4.6	2.9	2.4	7.2	7.4	7.8	8.1	8.1	6.4	5.1	4.6	3.0	2.4
62				7.5	7.7	7.8	6.3	4.9	4.5	2.8	2.3	61.0m x 6.9	6.8	7.2	7.6	7.6	6.3	5.0	4.6	2.9	2.4
64			7.0	7.2	7.3	6.2	4.8	4.4	2.7	2.3			6.7	7.0	7.1	6.3	4.9	4.5	2.8	2.3	
66				65.0m x 6.8	6.9	6.2	4.7	4.4	2.7	2.3			6.1	6.4	6.7	6.2	4.8	4.4	2.7	2.3	
68					6.5	6.2	4.6	4.3	2.6	2.2			66.5m x 6.0	5.8	6.2	6.2	4.7	4.4	2.7	2.3	
70					69.5m x 6.0	6.2	4.5	4.3	2.5	2.2				5.7	6.1	6.1	4.6	4.3	2.6	2.2	
72						71.0m x 6.1	4.4	4.3	2.4	2.2				5.2	5.5	4.5	4.3	2.5	2.2		
74							4.2	4.2	2.4	2.1					72.5m x 5.1	5.0	4.4	4.3	2.5	2.2	
76							75.0m x 4.1	4.2	2.3	2.1							4.3	4.3	2.4	2.1	
78								77.0m x 4.1	2.3	2.1							77.5m x 4				

Jib rated lifting loads (87ton counterweight, 16ton weight for body)

(Unit : Metric ton)

Boom length (m)	57										60												
	13		19		25		31		37		13		19		25		31		37				
	10°	30°	10°	30°	10°	30°	10°	30°	10°	30°	10°	30°	10°	30°	10°	30°	10°	30°	10°	30°			
No. of part line	2	2	2	1	1	1	1	1	1	1	2	2	1	1	1	1	1	1	1	1			
16	16.5m x 25.0										17.0m x 25.0												
18	25.0		18.5m x 22.0								25.0		19.5m x 21.8										
20	25.0	19.6	20.6		20.5m x 13.2						25.0	21.0m x 19.9	20.8		21.0m x 13.2								
22	25.0	18.9	19.9		13.0			22.5m x 7.2			25.0	19.0	20.1		13.0		23.0m x 7.2						
24	25.0	18.6	19.3	24.5m x 13.5	12.8		7.1		25.0m x 5.0		24.6	18.7	19.5	25.0m x 13.5	12.9		7.1		25.5m x 5.0				
26	24.2	18.0	18.7	13.5	12.6		7.0		5.0		23.6	18.3	19.0	13.5	12.7		7.0		5.0				
28	23.4	17.4	18.2	13.5	12.4	8.7	6.9		4.9		22.7	17.7	18.4	13.5	12.5		28.5m x 8.8		6.9				
30	22.6	16.9	17.7	13.2	12.2	8.6	6.8		4.8		22.1	17.1	17.9	13.3	12.3		8.6		6.8				
32	21.3	16.4	17.3	13.0	12.1	8.4	6.7	5.5	4.8		21.5	16.6	17.5	13.1	12.1		8.5		6.7	32.5m x 5.3			
34	20.1	15.9	16.8	12.6	11.9	8.3	6.6	5.5	4.6		19.8	16.2	17.0	12.8	12.0		8.4		6.6	5.5	4.7		
36	18.3	15.5	16.4	12.2	11.7	8.2	6.5	5.4	4.5	3.2	18.1	15.7	16.6	12.4	11.8		8.2		6.5	5.4	4.6	36.5m x 3.2	
38	16.8	15.1	16.0	11.9	11.5	8.0	6.4	5.3	4.4	3.2	16.6	15.3	16.3	12.1	11.6		8.1		6.4	5.4	4.5	3.2	
40	15.4	14.7	15.6	11.6	11.3	7.9	6.3	5.3	4.2	3.1	15.2	15.0	15.8	11.7	11.4		8.0		6.3	5.3	4.3	3.1	
42	14.2	14.4	14.8	11.3	11.1	7.8	6.2	5.2	4.1	3.1	13.9	14.5	14.5	11.4	11.3		7.8		6.2	5.3	4.1	3.1	
44	13.1	13.6	13.6	11.0	11.0	7.6	6.1	5.2	3.9	3.0	12.8	13.4	13.4	11.2	11.1		7.7		6.1	5.2	4.0	3.0	
46	12.1	12.5	12.6	10.7	10.8	7.5	6.0	5.1	3.8	2.9	11.8	12.3	12.4	10.9	10.9		7.6		6.0	5.2	3.9	3.0	
48	11.2	11.6	11.7	10.5	10.6	7.4	5.9	5.0	3.7	2.8	10.9	11.4	11.5	10.7	10.7		7.5		5.9	5.1	3.7	2.9	
50	10.3	10.7	10.8	10.3	10.4	7.2	5.8	5.0	3.6	2.8	10.1	10.5	10.6	10.4	10.5		7.3		5.8	5.0	3.6	2.8	
52	9.6	9.9	10.1	10.1	10.2	7.1	5.6	4.9	3.4	2.7	9.3	9.7	9.8	10.2	10.1		7.2		5.7	4.9	3.5	2.7	
54	8.8	9.1	9.4	9.9	9.7	7.0	5.5	4.8	3.3	2.6	8.6	8.9	9.1	9.7	9.4		7.1		5.6	4.9	3.4	2.7	
56	8.2	8.4	8.7	9.2	9.0	6.8	5.4	4.8	3.2	2.6	7.9	8.2	8.5	9.0	8.8		6.9		5.5	4.8	3.3	2.6	
58	7.5	7.8	8.1	8.5	8.4	6.7	5.3	4.7	3.1	2.5	7.2	7.5	7.8	8.3	8.2		6.8		5.4	4.8	3.2	2.6	
60	6.9	7.1	7.5	7.9	7.9	6.6	5.2	4.7	3.1	2.5	6.5	6.8	7.2	7.7	7.7		6.7		5.3	4.7	3.1	2.5	
62	6.2	6.4	6.9	7.3	7.4	6.4	5.1	4.6	3.0	2.4	5.9	6.2	6.6	7.1	7.2		6.6		5.2	4.6	3.0	2.5	
64	63.5m x 5.8	5.8	6.3	6.7	6.9	6.3	5.0	4.5	2.9	2.4	5.4	5.5	6.0	6.4	6.6		6.4		5.1	4.6	3.0	2.4	
66			5.8	6.1	6.3	6.3	4.9	4.5	2.8	2.3	4.8	5.0	5.4	5.8	6.0		6.3		5.0	4.5	2.9	2.4	
68			5.2	5.5	5.8	6.2	4.8	4.4	2.7	2.3		67.0m x 2.7	4.9	5.3	5.5		6.0		4.9	4.5	2.8	2.3	
70			69.0m x 5.0	5.0	5.3	5.7	4.7	4.4	2.7	2.3			4.4	4.7	5.0		5.5		4.4	4.4	2.7	2.3	
72				70.5m x 4.8	4.9	5.2	4.6	4.3	2.6	2.2			71.5m x 4.0	4.2	4.6		5.0		4.7	4.4	2.7	2.3	
74					4.4	4.7	4.5	4.3	2.5	2.2					73.0m x 3.9		4.1		4.5	4.4	2.6	2.2	
76					75.0m x 4.2	4.2	4.4	4.3	2.5	2.2							3.7		4.0	4.0	2.5	2.2	
78						76.5m x 4.1	4.0	4.3	2.4	2.1							77.5m x 3.4		3.6	3.6	2.0	2.5	2.2
80							3.7	3.9	2.3	2.1							79.0m x 3.3		3.3	3.6	2.4	2.1	
82							80.5m x 3.5	3.5	2.3	2.1									3.1	3.2	2.4	2.1	
84								82.5m x 3.4	2.2	2.1									83.0m x 2.8	2.9	2.3	2.1	
86									85.5m x 2.2	2.1										85.0m x 2.7	2.1	2.1	
88										2.1												2.1	
90										68.5m x 2.1												2.1	

Boom length (m)	63										66										
	13		19		25		31		37		13		19		25		31		37		
	10°	30°	10°	30°	10°	30°	10°	30°	10°	30°	10°	30°	10°	30°	10°	30°	10°	30°	10°	30°	
No. of part line	2	2	2	1	1	1	1	1	1	1	2	2	2	1	1	1	1	1	1	1	
16	17.5m x 25.0																				
18	25.0																				
20	25.0	21.5m x 19.6	20.9		21.5m x 13.2								25.0		20.5m x 21.8						
22	24.9	19.1	20.3		13.1								25.0	19.5	20.5		13.1				
24	24.3	18.8	19.7	25.5m x 13.5	12.9		7.2				24.5	18.9	19.9		13.0		24.5m x 7.2				
26	23.7	18.5	19.2	13.5	12.7		7.1		5.0		24.0	18.6	19.4	13.5	12.8		7.1		26.5m x 5.0		
28	23.2	17.9	18.6	13.5	12.6	29.0m x 8.8	7.0		5.0		23.3	18.1	18.8	13.5	12.6		7.0		5.0		
30	22.6	17.4	18.2	13.4	12.4	8.6	6.9		4.9		22.6	17.6	18.4	13.5	12.5		8.7		6.9		
32	21.8	16.9	17.7	13.2	12.2	8.5	6.8		4.8		21.5	17.1	17.9	13.2	12.3		8.6		6.8		
34	19.7	16.4	17.3	13.0	12.1	8.4	6.7	5.5	4.8		19.5	16.6	17.5	13.1	12.1		8.4		6.7	5.5	4.8
36	18.0	16.0	16.9	12.6	11.9	8.3	6.6	5.4	4.6		17.7	16.2	17.1	12.7	12.0		8.3		6.6	5.5	4.7
38	16.5	15.6	16.5	12.2	11.7	8.2	6.5	5.4	4.5	3.2	16.2	15.8	16.7	12.4	11.8		8.2		6.5	5.4	4.6
40	15.1	15.2	15.6	11.9	11.5	8.0	6.4	5.3	4.3	3.1	14.8	15.4	15.4	12.1	11.6		8.1		6.4	5.4	4.5
42	13.8	14.5	14.4	11.6	11.4	7.9	6.3	5.3	4.2	3.1	13.6	14.2	14.1	11.8	11.5		8.0		6.3	5.3	4.3
44	12.7	13.3	13.3	11.3	11.2	7.8	6.2	5.2	4.1	3.1	12.5	13.1	13.0	11.5	11.3		7.8		6.2	5.3	4.1
46	11.7	12.3	12.3	11.1	11.0	7.7	6.1	5.2	3.9	3.0	11.5	12.0	12.0	11.2	11.1		7.7		6.1	5.2	4.0
48	10.8	11.3	11.3	10.8	10.9	7.5	6.0	5.1	3.8	2.9	10.6	11.1	11.1	11.0	11.0		7.6		6.1	5.2	3.9
50	10.0	10.4	10.5	10.6	10.7	7.4	5.9	5.1	3.7	2.8	9.7	10.2	10.2	10.8	10.5		7.5		6.0	5.1	3.8
52	9.2	9.6	9.7	10.3	9.9	7.3	5.8	5.0	3.6	2.8	8.9	9.4	9.5	10.2	9.7		7.4		5.9	5.0	3.7
54	8.5	8.9	9.0	9.6	9.2	7.2	5.7	4.9	3.5	2.7	8.1	8.6	8.7	9.4	9.0		7.3		5.8	4.9	3.6
56	7.7	8.1	8.3	8.9	8.6	7.0	5.6	4.8	3.4	2.6	7.4	7.8	8.0	8.7	8.4						

Jib rated lifting loads (87ton counterweight, 16ton weight for body)

(Unit : Metric ton)

Boom length (m)	69								72																											
Jib length (m)	13				19				31				37				13				19				31				37							
Jib offset angle	10°		30°		10°		30°		10°		30°		10°		30°		10°		30°		10°		30°		10°		30°		10°		30°					
Working radius (m)	10°		30°		10°		30°		10°		30°		10°		30°		10°		30°		10°		30°		10°		30°		10°		30°					
No. of part line	2		2		1		1		1		1		1		1		1		1		1		1		1		1		1		1					
18	18.5m x 2.5																																			
20	25.0				21.0m x 21.8								19.0m x 28.0																							
22	25.0		22.5m x 19.5		20.7				23.0m x 13.1				25.0		23.0m x 19.5		20.8				23.5m x 13.2															
24	24.7		19.0		20.1				13.0				25.0m x 7.2								13.1				25.5m x 7.2											
26	24.2		18.7		19.5		26.5m x 13.5		12.8				7.1				27.0m x 5.0		24.4		18.8		19.7		27.0m x 13.5		12.7				7.1		27.5m x 5.0			
28	23.6		18.3		19.0		13.5		12.7				7.0				5.0		23.9		18.5		19.2		13.5		12.3				7.0		5.0			
30	23.2		17.8		18.6		13.5		12.5				6.9		30.5m x 8.8		6.9		4.9		22.8		18.0		18.7		13.5		11.9		31.0m x 8.8		7.0		5.0	
32	21.1		17.3		18.1		13.3		12.4		8.6		6.8				4.9		20.7		17.5		18.3		13.4		11.5		8.6		6.9		4.9			
34	19.3		16.8		17.7		13.1		12.2		8.5		6.7		5.5		4.8		19.1		17.0		17.9		13.2		11.1		8.5		6.8		34.5m x 8.5		4.8	
36	17.6		16.4		17.3		12.9		12.0		8.4		6.7		5.5		4.7		17.4		16.6		17.5		13.0		10.7		8.4		6.7		5.5		4.8	
38	16.1		16.0		16.6		12.6		11.9		8.3		6.6		5.4		4.6		15.9		16.2		16.4		12.7		10.3		8.3		6.6		5.4		38.5m x 3.2	
40	14.7		15.4		15.3		12.2		11.7		8.1		6.5		5.4		4.5		3.2		14.5		15.2		15.1		12.4		10.0		8.2		6.5		4.6	
42	13.4		14.1		14.0		11.9		11.6		8.0		6.4		5.3		4.3		3.1		13.2		14.0		13.9		12.1		9.8		8.1		6.4		5.3	
44	12.3		13.0		12.9		11.6		11.4		7.9		6.3		5.3		4.2		3.1		12.1		12.8		12.7		11.8		9.6		8.0		6.3		5.3	
46	11.3		11.9		11.8		11.4		11.2		7.8		6.2		5.2		4.1		3.1		11.1		11.8		11.7		11.5		9.4		7.9		6.3		5.3	
48	10.4		10.9		10.9		11.1		11.0		7.7		6.1		5.2		4.0		3.0		10.2		10.8		10.7		11.3		9.2		7.8		6.2		5.2	
50	9.5		10.0		10.1		10.8		10.2		7.6		6.0		5.1		3.8		2.9		9.3		9.9		9.9		10.7		9.0		7.6		6.1		5.2	
52	8.7		9.2		9.3		10.1		9.4		7.5		5.9		5.1		3.7		2.8		8.4		9.0		9.1		9.9		8.8		7.5		6.0		5.1	
54	7.9		8.4		8.5		9.3		8.7		7.3		5.8		5.0		3.6		2.8		7.6		8.2		8.3		9.1		8.6		7.4		5.9		5.0	
56	7.1		7.6		7.8		8.6		8.3		7.2		5.8		4.9		3.5		2.7		6.8		7.3		7.5		8.3		8.1		7.3		5.8		5.0	
58	6.4		6.8		7.0		7.8		7.7		7.1		5.7		4.9		3.4		2.6		6.1		6.6		6.8		7.6		7.4		7.2		5.7		4.9	
60	5.7		6.1		6.4		7.1		7.0		7.0		5.6		4.8		3.3		2.6		5.5		5.9		6.1		6.8		6.7		7.1		5.6		4.8	
62	5.1		5.5		5.8		6.4		6.4		6.8		5.5		4.8		3.2		2.5		4.9		5.2		5.5		6.2		6.1		6.6		5.6		4.8	
64	4.6		4.9		5.2		5.8		5.8		6.5		5.4		4.7		3.2		2.5		4.3		4.6		4.9		5.5		5.5		6.4		5.5		4.8	
66	4.0		4.3		4.6		5.2		5.2		5.9		5.3		4.7		3.1		2.5		3.7		4.1		4.4		4.9		5.0		5.7		5.0		4.7	
68	3.5		3.8		4.1		4.6		4.7		5.4		4.8		4.6		3.0		2.4		3.2		3.5		3.8		4.4		4.4		5.1		4.5		4.7	
70	3.0		3.2		3.6		4.1		4.2		4.8		4.3		4.6		2.9		2.4		2.8		3.0		3.4		3.9		3.9		4.6		4.1		4.6	
72	2.6		2.8		3.2		3.6		3.8		4.3		3.9		4.5		2.9		2.3		2.3		2.5		2.9		3.4		3.5		4.1		3.8		4.3	
74			2.3		2.8		3.1		3.3		3.8		3.7		4.0		2.8		2.3				2.1		2.5		2.9		3.1		3.6		3.6		3.8	
76					2.3		2.7		2.9		3.4		3.4		3.6		2.7		2.3				2.1		2.4		2.6		3.2		3.1		3.4		2.8	
78							2.2		2.5		2.9		3.0		3.2		2.7		2.2								2.3		2.7		2.7		3.0		2.3	
80									2.2		2.5		2.6		2.9		2.2		2.2								2.3		2.3		2.9		2.2		2.2	
82											2.1		2.2		2.8		2.2		2.2														2.5			
84													2.4																				2.1			

Notes

1. All rated loads are based on the machine being operated on the firm, level, uniformly supporting surface ground, at any point of 360-around the machine within 78% of tipping load and forward stability factor over 1.15.

Working radius is horizontal distance from center of rotation to a vertical line through the center of gravity of the load.

2. To determine actual lifting loads, the weight of all lifting devices such as hook must be reduced from the lifting loads.

280 ton hook3,300 kg	60 ton hook1,200 kg
200 ton hook2,700 kg	30/25 ton hook1,000 kg
150 ton hook2,400 kg	13.5 ton hook600 kg
100 ton hook1,400 kg		

3. The following weight must be reduced from the lifting loads to determine rated lifting loads for main boom when the jib is equipped.

Aux. Jib800 kg	25.0 m jib4,900 kg
13.0 m jib3,500 kg	31.0 m jib6,000 kg
19.0 m jib4,000 kg	37.0 m jib6,700 kg

4. Depending on the number of part lines, rated lifting loads are limited as follows;

1 part lineupto 13.5 ton	10 part lineupto 125.0 ton
2 part lineupto 25.0 ton	11 part lineupto 137.5 ton
3 part lineupto 37.5 ton	12 part lineupto 150.0 ton
4 part lineupto 50.0 ton	13 part lineupto 162.5 ton
5 part lineupto 62.5 ton	14 part lineupto 175.0 ton
6 part lineupto 75.0 ton	15 part lineupto 187.5 ton
7 part lineupto 87.5 ton	16 part lineupto 200.0 ton
8 part lineupto 100.0 ton	20 part lineupto 280.0 ton
9 part lineupto 112.5 ton		

5. The Aux. jib can be equipped with the range of boom length from 18 m to 87 m boom. To determine the rated lifting loads, 0.8 ton is reduced from the lifting loads in the same boom length in the lifting load chart.. However the max. lifting loads should not exceed the 13.5 ton.

6. When the 13 m~37 m jib mounted, the lifting loads to be determined by "Jib Rated Lifting Loads".

7. The total weight of the main hook and the jib hook must be reduced from the rated load when lifting on the Jib hook with the main hook being attached.

8. The angle formed by the extension line of main boom and the centerline of jib (offset angle) should not exceed 30 degree while the loads being lifted.

Aux.Jib Rated Lifting Loads (87ton counterweight, 16ton weight for body)

(Unit : Metric ton)

Boom length(m) Working radius(m)	18	21	24	27	30	33	36	39	42	45	48	51	54	57	60	63	66	69	72	75	78	81	84	87
No. of Part line	1	1	1	1	1	1	1	1	1	1	1	1	1	1	1	1	1	1	1	1	1	1	1	1
6	13.5	6.5m x 13.5																						
7	13.5	13.5	7.0m x 13.5	7.5m x 13.5																				
8	13.5	13.5	13.5	13.5	8.0m x 13.5	8.6m x 13.5																		
9	13.5	13.5	13.5	13.5	13.5	13.5	9.1m x 13.5	9.6m x 13.5																
10	13.5	13.5	13.5	13.5	13.5	13.5	13.5	13.5	10.1m x 13.5	10.6m x 13.5	11.2m x 13.5	11.7m x 13.5												
12	13.5	13.5	13.5	13.5	13.5	13.5	13.5	13.5	13.5	13.5	13.5	13.5	12.2m x 13.5	12.7m x 13.5	13.3m x 13.5	13.8m x 13.5								
14	13.5	13.5	13.5	13.5	13.5	13.5	13.5	13.5	13.5	13.5	13.5	13.5	13.5	13.5	13.5	13.5	14.3m x 13.5	14.8m x 13.5	15.3m x 13.5	15.9m x 13.5				
16	13.5	13.5	13.5	13.5	13.5	13.5	13.5	13.5	13.5	13.5	13.5	13.5	13.5	13.5	13.5	13.5	13.5	13.5	13.5	13.5	16.4m x 13.5	16.9m x 13.5	17.4m x 13.5	17.9m x 13.5
18	17.2m x 13.5	13.5	13.5	13.5	13.5	13.5	13.5	13.5	13.5	13.5	13.5	13.5	13.5	13.5	13.5	13.5	13.5	13.5	13.5	13.5	13.5	13.5	13.5	13.5
20		19.8m x 13.5	13.5	13.5	13.5	13.5	13.5	13.5	13.5	13.5	13.5	13.5	13.5	13.5	13.5	13.5	13.5	13.5	13.5	13.5	13.5	13.5	13.5	13.5
22			13.5	13.5	13.5	13.5	13.5	13.5	13.5	13.5	13.5	13.5	13.5	13.5	13.5	13.5	13.5	13.5	13.5	13.5	13.5	13.5	13.5	13.5
24			22.4m x 13.5	13.5	13.5	13.5	13.5	13.5	13.5	13.5	13.5	13.5	13.5	13.5	13.5	13.5	13.5	13.5	13.5	13.5	13.5	13.5	13.5	13.5
26				25.0m x 13.5	13.5	13.5	13.5	13.5	13.5	13.5	13.5	13.5	13.5	13.5	13.5	13.5	13.5	13.5	13.5	13.5	13.5	13.5	13.5	13.5
28					27.6m x 13.5	13.5	13.5	13.5	13.5	13.5	13.5	13.5	13.5	13.5	13.5	13.5	13.5	13.5	13.5	13.5	13.5	13.5	13.5	13.5
30						13.5	13.5	13.5	13.5	13.5	13.5	13.5	13.5	13.5	13.5	13.5	13.5	13.5	13.5	13.5	13.5	13.5	13.5	13.5
32						30.2m x 13.5	13.5	13.5	13.5	13.5	13.5	13.5	13.5	13.5	13.5	13.5	13.5	13.5	13.5	13.5	13.5	13.5	13.5	13.5
34							32.8m x 13.5	13.5	13.5	13.5	13.5	13.5	13.5	13.5	13.5	13.5	13.5	13.5	13.5	13.5	13.5	13.5	13.5	13.5
36								35.4m x 13.5	13.5	13.5	13.5	13.5	13.5	13.5	13.5	13.5	13.5	13.5	13.5	13.5	13.5	13.5	13.5	13.5
38									13.5	13.5	13.5	13.5	13.5	13.5	13.5	13.5	13.5	13.5	13.5	13.5	13.5	13.5	13.5	13.5
40										13.5	13.5	13.5	13.5	13.5	13.5	13.5	13.5	13.5	13.5	13.5	13.5	13.5	13.5	13.3
42										40.6m x 13.5	13.5	13.5	13.5	13.5	13.5	13.4	13.2	13.0	13.3	13.0	12.8	12.6	12.3	12.1
44										43.2m x 13.5	13.1	13.0	12.6	12.6	12.3	12.1	11.9	12.2	11.9	11.7	11.5	11.2	10.8	
46											45.8m x 12.4	12.0	11.7	11.7	11.4	11.2	11.0	11.2	10.9	10.7	10.5	10.2	9.8	
48												11.2	10.9	10.8	10.5	10.3	10.1	10.3	10.0	9.8	9.6	9.3	8.9	
50													48.4m x 11.0	10.1	9.7	9.5	9.3	9.5	9.2	9.0	8.8	8.4	8.1	
52														51.0m x 9.7	9.3	9.0	8.8	8.6	8.8	8.4	8.2	7.9	7.7	7.2
54															53.6m x 8.6	8.4	8.2	7.9	8.1	7.6	7.4	7.1	7.0	6.4
56																7.8	7.5	7.2	7.3	6.9	6.6	6.4	6.5	5.7
58																56.2m x 7.7	7.0	6.7	6.6	6.2	5.9	5.7	5.8	5.0
60																	58.8m x 6.7	6.1	6.0	5.5	5.3	5.0	5.1	4.5
62																		61.4m x 5.6	5.4	4.9	4.7	4.4	4.5	3.9
64																			4.8	4.5	4.3	3.8	3.9	3.3
66																				4.0	3.8	3.3	3.4	2.8
68																				66.6m x 3.8	3.3	3.0	2.9	2.3
70																					69.2m x 3.0	2.5	2.4	
72																						71.8m x 2.1		

Individual masses and outline dimensions

Main body

Main part name	Mass (tons)	Q'ty	dimensions (m) L×W×H
Main body (without "A"frame,ropes and crawlers)	(41.3)	(1)	7.95×3.38×3.19
Main body (with "A"frame,ropes, and without crawlers)	(48.0)	(1)	9.6×3.38×3.56
Crawler	23.3	2	9.18×1.57×1.37
Counterweight, weight for body	103.6	11	See the right

Crane attachment

Main part name	Mass (tons)	Q'ty	dimensions (m) L×W×H
Inner boom (with boom limit stop)	3.3	1	7.74×2.35×2.65
Outer boom (with pendant rope)	4.3	1	11.3×2.35×2.45
3m insert boom (with pendant rope)	0.9	As required	3.14×2.35×2.43
6m insert boom (with pendant rope)	1.4	As required	6.14×2.35×2.43
9m insert boom (with pendant rope)	1.9	As required	9.14×2.35×2.43
Equalizer	0.8	1	2.27×1.14×0.38
Mast	2.5	1	10.73×1.91×0.90
Inner jib (with jib strut pendant rope)	1.2	1	6.93×1.25×1.30
Outer jib (with pendant rope)	0.6	1	6.85×1.08×1.07
1m aux. jib	0.4	1	1.97×0.44×0.64
6m insert jib (with pendant rope)	0.3	As required	6.08×1.08×1.08
280ton hook	3.3	1	3.25×1.10×0.73
200ton hook	2.7	1	2.33×0.73×1.03
150ton hook	2.4	1	2.21×0.82×0.85
100ton hook	1.4	1	1.97×0.73×0.54
60ton hook	1.2	1	1.77×0.80×0.50
30ton, 25ton (for jib operations) hook	1.0	1	1.74×0.79×0.35
13.5ton hook	0.6	1	1.52×0.46×0.46
Sheave block (for 280ton lifting)	0.5	1	1.34×0.92×0.51

Counterweight arrangement and dimensions (mm)

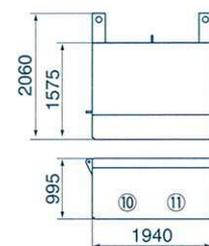
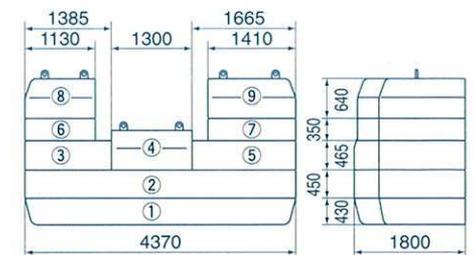

Weight (tons)	
①	18.5
②	18.6
③	6.2
④	9.8
⑤	7.8
⑥	4.2
⑦	5.4
⑧	7.5
⑨	9.6
⑩	8.0
⑪	8.0
Total	103.6

- ◆ Diagrams shown have been drawn for catalog purpose and may differ from actual products.
- ◆ Specifications are subject to change without notice due to technical improvements or modifications.

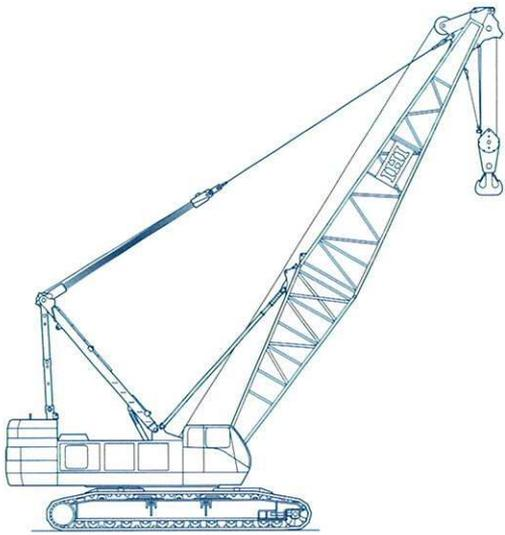

1. Ready for disassembly

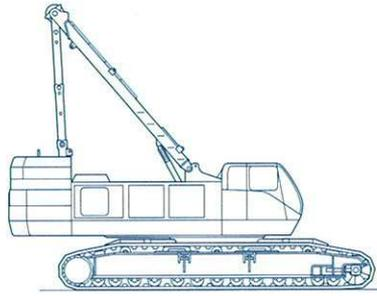

2. Removing the attachment

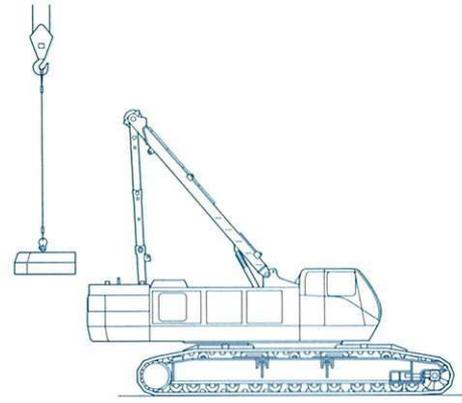

3. Removing the counter weights

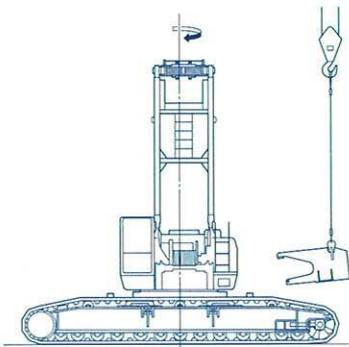

4. Removing the carbody weights

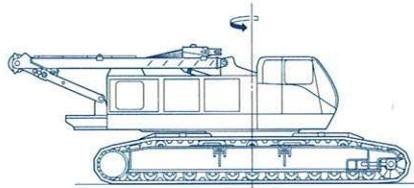

5. Folding the A-frame

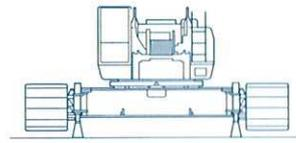

6. Jack up

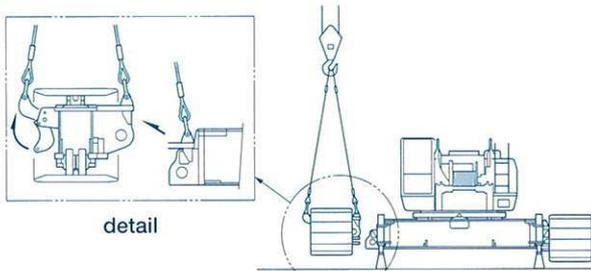

7. Removing the crawlers

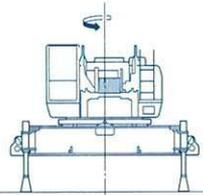

8. Slewing the upper machine

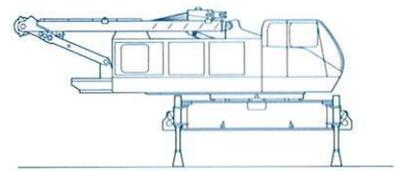

9. Jack up

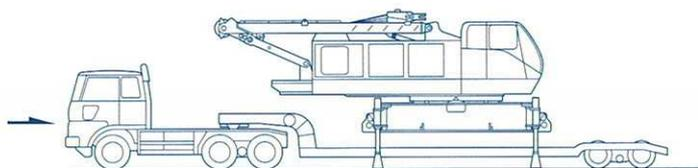

10. Loading the trailer

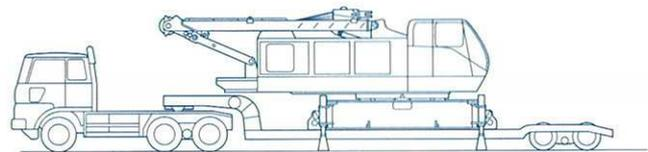

11. Loading the base machine

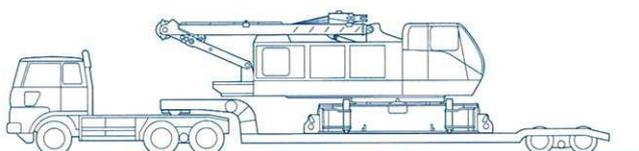

12. Folding the jack frame

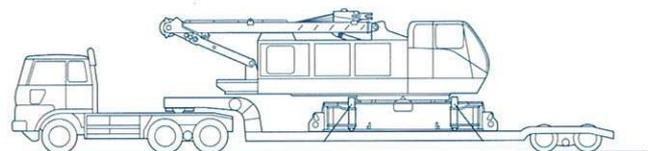

13. Figure of transport

OPERATOR ORIENTED DESIGN ENSURES SAFE AND EFFECTIVE OPERATION OF GREAT 280-TON

Highest rope speeds in this class 120 meter/minute Load Hoist/Lowering

Quick and easy works

Crawler frames are pin-jointed to carbody through hydraulic cylinders, which is to serve for quick and easy assembling and disassembling works. Traction motors and its hydraulic pipings are Shoe-in type (1,220 mm width) to avoid the damage by obstacles.

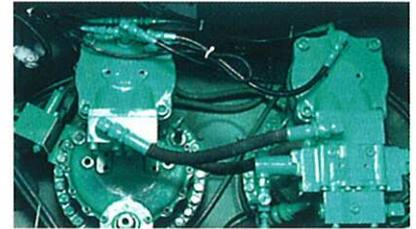
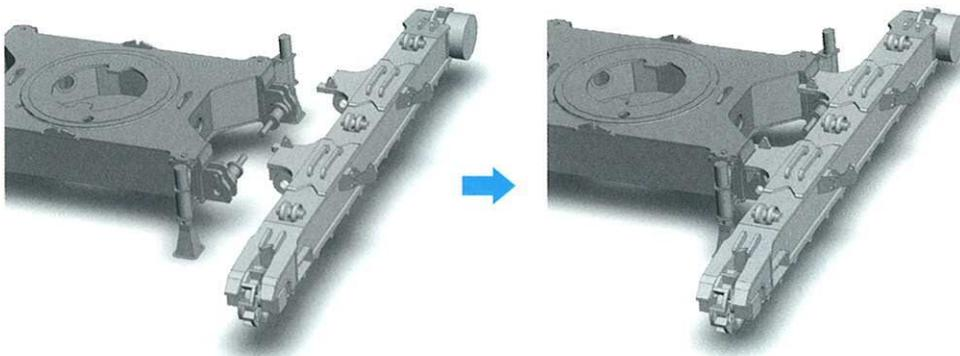

Powerful Swing

Powerful double-hydraulic-motor for swing motion is independent from all other operations.



Full Power-Efficient Hydraulic Control System

Two variable displacement pumps and one gear pump incorporated into engine provide the most effective usage of engine output. Hydraulic flow and pressures are automatically regulated to deliver high flow and low pressure for lighter loads, low flow and high pressure under heavy loading.

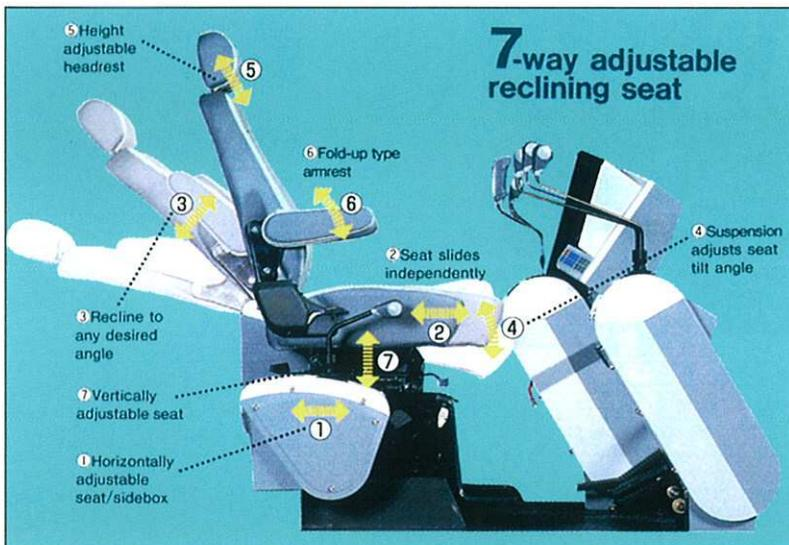

Dial system controller

Hydraulic pump delivery volume is controlled in conjunction with engine speed and independent swashplate angle control dial. The device provides easy, accurate and precise inching work.



Wide visibility and deluxe control stands

Dazzle free front glass, radio, intermittent windshield wiper, sunshade, stowbox are standard equipped. Levers, pedals, switches are logically located for safe and easy operation. Engine throttle switch is integrated on swing lever grip. Winch mode switch (select foot or automatic) is located on main and aux. hoist levers.



IHI **IHI Construction Machinery Limited**
Kishi-Tokai Bldg., 8-4-4, Nishikamata, Ota-ku, Tokyo 144-8577, JAPAN
Phone: 81-3-5714-8844 Fax: 81-3-5714-8840, 8841

Specifications are subject to change without notice due to technical improvements or modifications.
Distributed by



Printed in Japan
IK1283A0605LL20

Courtesy of Crane.Market